

## Data Sheet

# HL6321G/22G

638nm / 15mW     AlGaInP Laser Diode

# USHIO

### Outline

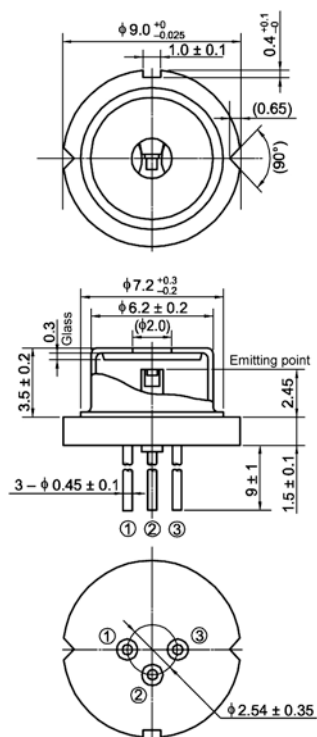

(unit: mm)

### Internal Circuit

#### HL6321G

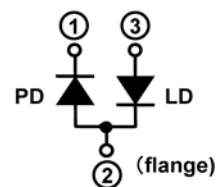

#### HL6322G

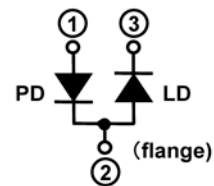

### Features

- Optical output power: 15mW(CW)
- Visible light output: 638nm Typ.
- Low operating current: 100mA Max.
- Low operating voltage: 2.7V Max.
- TM mode oscillation
- Single transverse mode

### Application

- Laser lever
- Laser module
- Optical equipment for measurement

### Absolute Maximum Ratings (Tc=25°C)

Item	Symbol	Ratings	Unit
Optical output power	Po	15	mW
LD Reverse Voltage	V <sub>R(LD)</sub>	2	V
PD Reverse Voltage	V <sub>R(PD)</sub>	30	V
Operating Temperature	Topr	-10 ~ +50	°C
Storage Temperature	Tstg	-40 ~ +85	°C

### Optical and Electrical Characteristics (Tc=25°C)

Parameter	Symbol	Min	Typ	Max	Unit	Test Condition
Threshold current	I <sub>th</sub>	20	55	70	mA	-
Operating current	I <sub>op</sub>	-	85	100	mA	Po=15mW
Operating voltage	V <sub>op</sub>	-	-	2.7	V	Po=15mW
Slope efficiency	η <sub>s</sub>	0.3	-	0.7	mW/mA	9(mW)/(I <sub>(12mW)</sub> - I <sub>(3mW)</sub> )
Monitor current	I <sub>s</sub>	0.1	0.2	0.4	mA	Po=15mW, V <sub>R(PD)</sub> =5V
Lasing Wavelength	λ <sub>p</sub>	630	638	640	nm	Po=15mW
Beam divergence Parallel to the junction	θ <sub>//</sub>	6	8	11	°	Po=15mW FWHM
Beam divergence Perpendicular to the junction	θ <sub>⊥</sub>	25	30	36	°	Po=15mW FWHM

## Typical Characteristic Curves

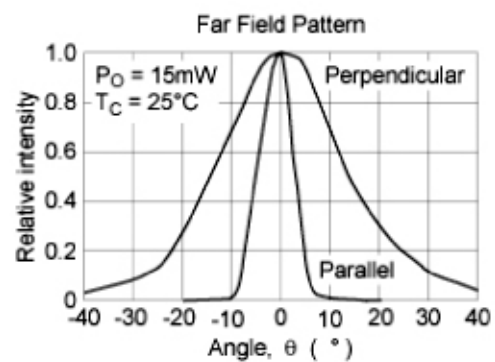
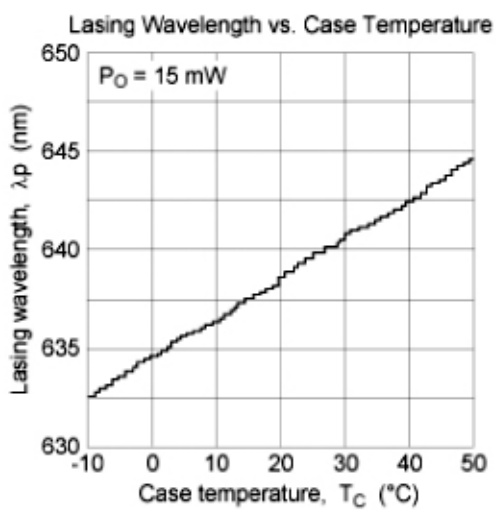
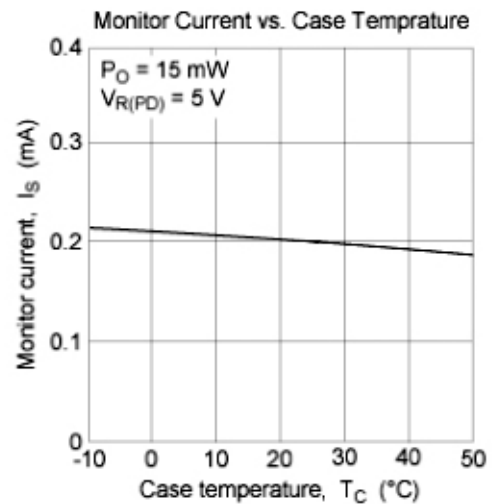
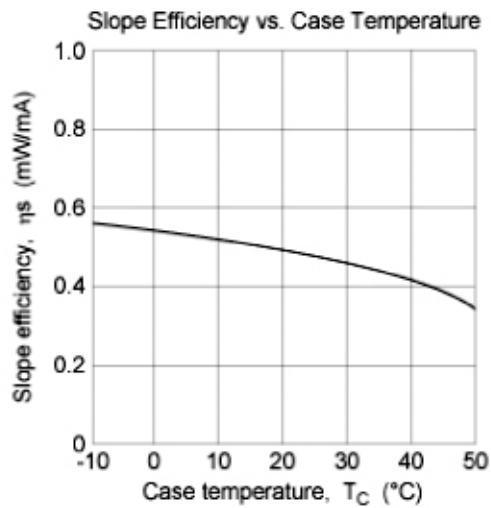
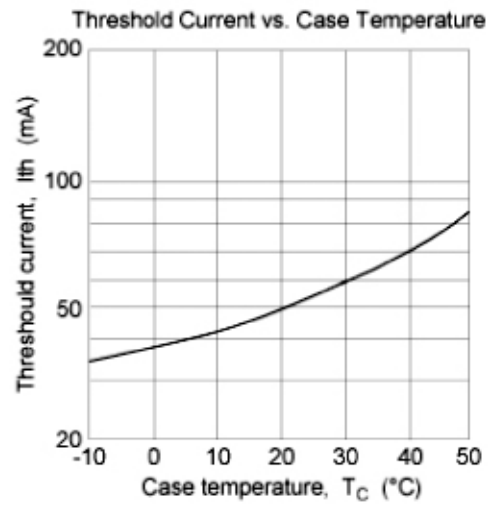
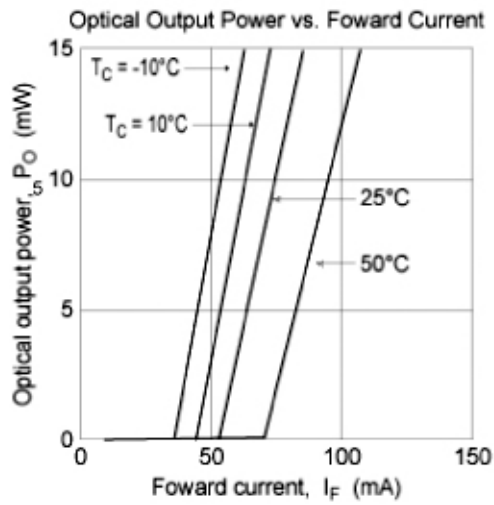

## Cautions

- 1.USHIO OPTO SEMICONDUCTORS,INC.(UOS) neither warrants nor grants licenses of any our lights or any third party's patent, copyright, trademark, or other intellectual property rights for information contained in this document, UOS bears no responsibility for problems that may arise with third party's right, including intellectual property rights, in connection with use of the information contained in this document.
- 2.Products and product specifications may be subject to change without notice. Confirm that you have received the latest product standards or specifications before final design, purchase or use.
- 3.UOS makes every attempt to ensure that its products are of high quality and reliability. However, contact our sales office before using the product in an application that demands especially high quality and reliability or where its failure or malfunction may directly threaten human life or cause risk of bodily injury, such as aerospace, aeronautics, nuclear power, combustion control, transportation, traffic safety equipment or medical equipment for life support.
- 4.Design your application so that the products is used within the ranges guaranteed by UOS. particularly for maximum rating, operating supply voltage range, heat radiation characteristics, installation conditions and other characteristics. UOS. bears no responsibility for failure or damage when used beyond the guaranteed ranges. Even within the guaranteed ranges, consider normally foreseeable failure rates or failure modes in semiconductor devices and employ systemic measures such as fail-safes, so that the equipment incorporating UOS product does not cause bodily injury, fire or other consequential damage due to operation of the UOS product.
- 5.This product is not designed to be radiation resistant.
- 6.No one is permitted to reproduce or duplicate, in any form, the whole or part of this document without written approval from UOS.
- 7.Contact our sales office for any questions regarding this document or UOS products.

- 1.The laser light is harmful to human body especially to eye no matter what directly or indirectly. The laser beam shall be observed or adjusted through infrared camera or equivalent.
- 2.This product (without violet laser diode) contains gallium arsenide (GaAs), which may seriously endanger your health even at very low doses. Please avoid treatment which may create GaAs powder or gas, such as disassembly or performing chemical experiments, when you handle the product. When disposing of the product, please follow the laws of your country and separate it from other waste such as industrial waste and household garbage.

## Important Notice

Performance figures, data and any illustrative material provided in this data sheet are typical and must be specifically confirmed in writing by UOS before they become applicable to any particular order or contract. In accordance with the UOS policy of continuous improvement specifications may change without notice. Further details are available from any UOS sales representative.



Caution - use of controls or adjustments or performance of procedures other than those specified herein may result in hazardous radiation exposure.